

Customer Service Note

Product Marks, Product Labels, and Packaging Labels

Introduction

Micron uses various marks and labels on our products and packaging. The first section of this customer service note describes the product marks and labels we place on our devices. The second section describes the labels used on and in our packaging.

Important Notes and Warnings

Micron Technology, Inc. ("Micron") reserves the right to make changes to information published in this document, including without limitation specifications and product descriptions. This document supersedes and replaces all information supplied prior to the publication hereof. You may not rely on any information set forth in this document if you obtain the product described herein from any unauthorized distributor or other source not authorized by Micron.

Automotive Applications. Products are not designed or intended for use in automotive applications unless specifically designated by Micron as automotive-grade by their respective data sheets. Distributor and customer/distributor shall assume the sole risk and liability for and shall indemnify and hold Micron harmless against all claims, costs, damages, and expenses and reasonable attorneys' fees arising out of, directly or indirectly, any claim of product liability, personal injury, death, or property damage resulting directly or indirectly from any use of non-automotive-grade products in automotive applications. Customer/distributor shall ensure that the terms and conditions of sale between customer/distributor and any customer of distributor/customer (1) state that Micron products are not designed or intended for use in automotive applications unless specifically designated by Micron as automotive-grade by their respective data sheets and (2) require such customer of distributor/customer to indemnify and hold Micron harmless against all claims, costs, damages, and expenses and reasonable attorneys' fees arising out of, directly or indirectly, any claim of product liability, personal injury, death, or property damage resulting from any use of non-automotive-grade products in automotive applications.

Critical Applications. Products are not authorized for use in applications in which failure of the Micron component could result, directly or indirectly in death, personal injury, or severe property or environmental damage ("Critical Applications"). Customer must protect against death, personal injury, and severe property and environmental damage by incorporating safety design measures into customer's applications to ensure that failure of the Micron component will not result in such harms. Should customer or distributor purchase, use, or sell any Micron component for any critical application, customer and distributor shall indemnify and hold harmless Micron and its subsidiaries, subcontractors, and affiliates and the directors, officers, and employees of each against all claims, costs, damages, and expenses and reasonable attorneys' fees arising out of, directly or indirectly, any claim of product liability, personal injury, or death arising in any way out of such critical application, whether or not Micron or its subsidiaries, subcontractors, or affiliates were negligent in the design, manufacture, or warning of the Micron product.

Customer Responsibility. Customers are responsible for the design, manufacture, and operation of their systems, applications, and products using Micron products. ALL SEMICONDUCTOR PRODUCTS HAVE INHERENT FAILURE RATES AND LIMITED USEFUL LIVES. IT IS THE CUSTOMER'S SOLE RESPONSIBILITY TO DETERMINE WHETHER THE MICRON PRODUCT IS SUITABLE AND FIT FOR THE CUSTOMER'S SYSTEM, APPLICATION, OR PRODUCT. Customers must ensure that adequate design, manufacturing, and operating safeguards are included in customer's applications and products to eliminate the risk that personal injury, death, or severe property or environmental damages will result from failure of any semiconductor component.

Limited Warranty. In no event shall Micron be liable for any indirect, incidental, punitive, special or consequential damages (including without limitation lost profits, lost savings, business interruption, costs related to the removal or replacement of any products or rework charges) whether or not such damages are based on tort, warranty, breach of contract or other legal theory, unless explicitly stated in a written agreement executed by Micron's duly authorized representative.

Product Marks and Labels

Most of Micron’s component products use one of two product mark variations to accommodate smaller components and different package sizes (for example, FBGA and CSP). Both product marks are right- and left-justified and have a character height of 0.030–0.050 inches depending on package size. Both marks also include a unique, laser-inscribed identification number on the top side of the part for traceability purposes.

Legacy component products with Elpida part marks use the same part marks used prior to the Micron acquisition of Elpida. Further information may be found in Micron product guides and at the Micron Web site: www.micron.com/numbering.

Component Mark Information

Most component marks contain the following details shown in the table that follows (also see [Figure 1: TSOP Component Mark](#) on page 4).

Table 1: Component Marks

Date code (year and work week)	Micron® mark or logo	Device Version	Die Revision
Special mark characters	Product family	Package type	Scribe (optional)
Country of diffusion ¹	Process technology	Speed	–
Country of encapsulation ¹	Device Number	Special test option (if revelant)	–

Note: 1. See table that follows for specific country code.

For more information on product-specific designators, see the part numbering guides on the Micron Web site: www.micron.com/numbering. Codes for countries of diffusion and encapsulation are shown in the Country Codes table that follows:

Table 2: Country Codes

1 = USA	4 = Japan	8 = Korea	C = Ireland	G = India
2 = Singapore	5 = China	9 = Mixed	D = Malaysia	
3 = Italy	7 = Taiwan	B = Israel	F = Phillippines	

Figure 1: TSOP Component Mark

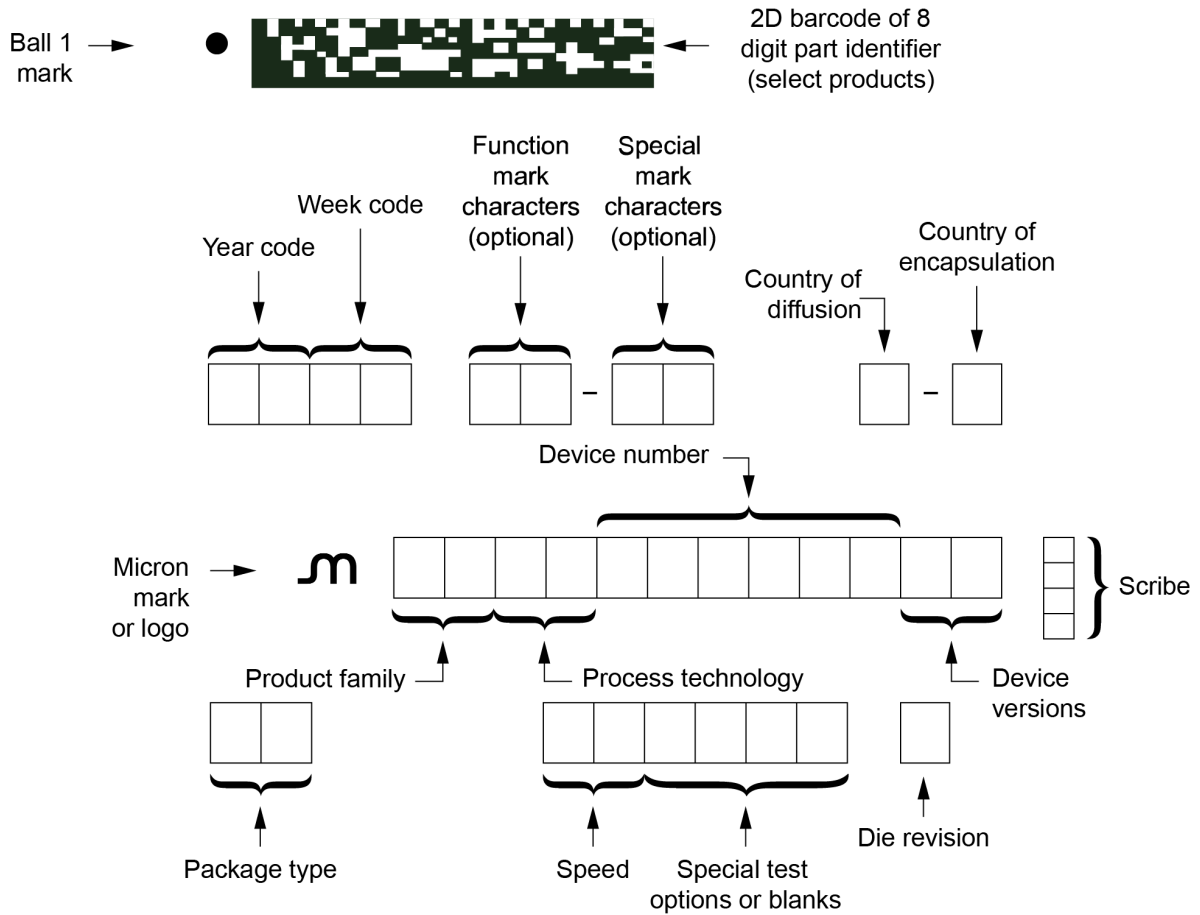

Abbreviated Component Mark Information

Due to space limitations, FBGA-package component marks contain abbreviated details for two distinct types of information (see [Figure 2: SOP2/W-PDFN/BGA/LGA Abbreviated Component Mark](#) on page 6). The top row of the component mark contains the flooring details that are unrelated to product type:

- Date code (see below)
- Die revision
- Country of diffusion (see [Table 2](#) for country codes)
- Country of encapsulation (see [Table 2](#) for country codes)

Date codes in the following listing are alphanumeric characters that indicate the year and the work-week the parts were marked, in even-numbered work-weeks. The first character is the last number in the year, and the second (alpha) character is the work-week.

A = 2	D = 8	G = 14	J = 20	M = 26	P = 32	S = 38	V = 44	Y = 50
B = 4	E = 10	H = 16	K = 22	N = 28	Q = 34	T = 40	W = 46	Z = 52
C = 6	F = 12	I = 18	L = 24	O = 30	R = 36	U = 42	X = 48	

Codes for countries of diffusion and encapsulation are in [Table 2: Country Codes](#) on page 3. The middle and bottom rows of the component mark contain product-specific details such as:

- Micron logo/ball 1 designator
- Coded part number
- Product family
- Special mark characters

More information on product-specific designators is provided in the various Micron part numbering guides, which are available at <http://www.micron.com/numbering>.

Information on the corresponding part numbers for part mark codes is available from the FBGA Part Marking Decoder at <https://www.micron.com/sales-support/design-tools/fbga-parts-decoder>.

Figure 2: SOP2/W-PDFN/BGA/LGA Abbreviated Component Mark

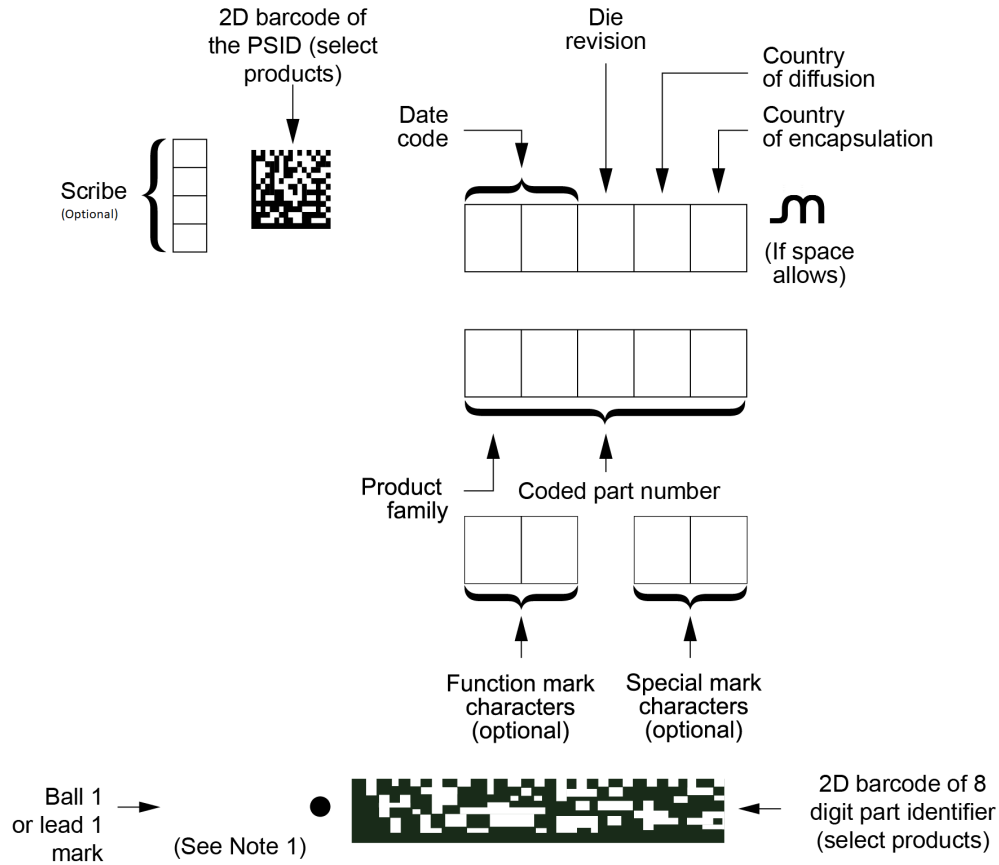

Notes: 1. If the "MT" and "dot" are both present, ball 1 or lead 1 are identified by the "dot."

2. For BGA packages, the scribe and ball 1 or lead 1 indicator may swap positions if the package is wider than its length. The scribe and ball 1 or lead 1 indicator will always be marked along the short side of the component.

Figure 3: Legacy BGA Component with Elpida Part Mark

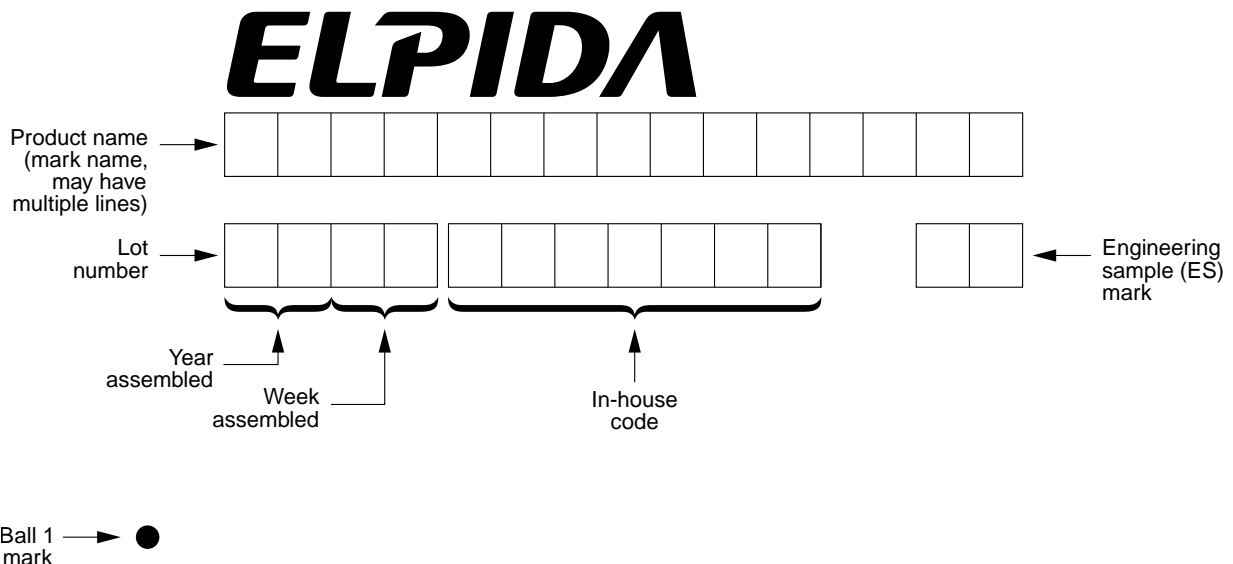

Module Label Data and Examples

Labels used for module production have standard requirements for each line printed on the label, but can vary by type (see [DDR5 Module Content: LRDIMM, RDIMM, UDIMM, and SODIMM](#) on page 8 through [DDR4/DDR3 Module Content: ECC UDIMM/SODIMM](#) on page 14). Micron module label content and format conform to JEDEC label specifications.

DDR5 Module Content: LRDIMM, RDIMM, UDIMM, and SODIMM

Figure 4: DDR5 LRDIMM, RDIMM, UDIMM, and SODIMM Module Label Content

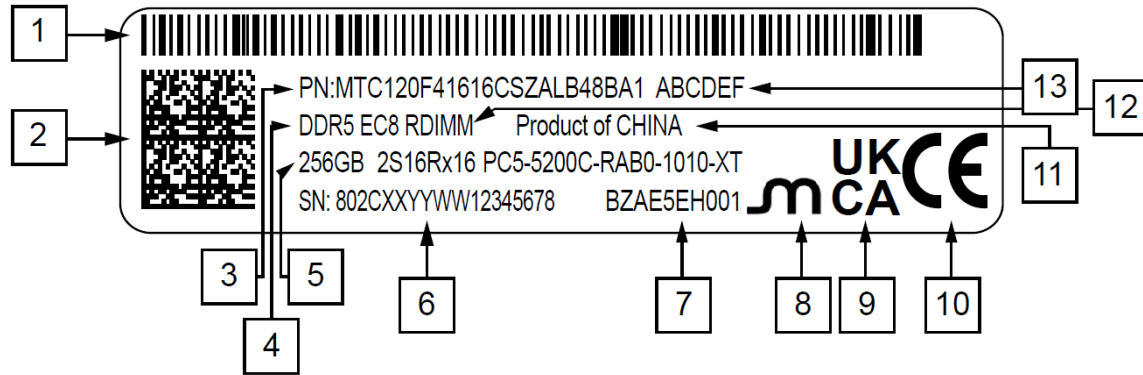

Table 3: Label Definitions: DDR5 LRDIMM to SODIMM

Note #	Definition
1	Code 128 subset B bar code (per ISO/IEC 15417:2007) of Micron part number/datecode (YYWW) with a space separator between the data. Example: MTC120F41616CSZALB48BA1 126
2	2D barcode (see JEDEC DDR5 DIMM Label Specification): (L) technical details (S) serial number (P) part number (c) process code.
3	Micron DRAM module marketing part number: For more information about module part numbering, see Module Part Numbering Systems on https://www.micron.com .
4	DRAM technology.
5	JEDEC technical details (see JEDEC DDR5 DIMM Label Specification): -Module capacity, ranks, and number of data lines per DRAM device (256GB 2S16R x 16 shown) -DRAM technology (PC5 shown) -Module speed bin (5200C shown) -Module type, reference raw card and revision (RAB0 shown) -JEDEC SPD revision (1010 shown) -Temperature grade (XT shown)
6	JEDEC serial number (see JEDEC DDR5 DIMM Label Specification): -Micron’s JEDEC manufacturer code, 802C (constant on all modules) -Manufacturing location (two characters, variable—see Table 14) -Date code (four characters: YYWW) -Module serial number (eight characters, unique to each module)
7	Module build lot ID.
8	Micron logo.
9	The UK Regulatory Requirement mark (may or may not be present on a particular module label).
10	The European Regulatory Requirement mark (may or may not be present on a particular module label).
11	Module assembly country of origin; Micron uses: -“Made in Taiwan” for Taiwan origin product -“Assembled in USA” for US origin product -“Product of xxx” for products of other origins
12	Module DIMM type.
13	A process code is printed after the last character of module part numbers (ABCDEF shown; see Process Codes: DDR5). This additional information provided is not part of the module part number.

DDR5 Module Content: MRDIMM

Figure 5: DDR5 MRDIMM Module Label Content



Table 4: Label Definitions: DDR5 MRDIMM

Note #	Definition
1	Code 128 subset B bar code (per ISO/IEC 15417:2007) of Micron part number/datecode (YWW) with a space separator between the data. Example: MTC80F4048M1HC1AXB1 126
2	2D barcode (see JEDEC DDR5 DIMM Label Specification): (L) technical details (S) serial number (P) part number (c) process code.
3	Micron DRAM module marketing part number: For more information about module part numbering, see Module Part Numbering Systems on https://www.micron.com .
4	DRAM technology.
5	JEDEC serial number (see JEDEC DDR5 DIMM Label Specification): -Micron’s JEDEC manufacturer code, 802C (constant on all modules) -Manufacturing location (two characters, variable—see Table 14) -Date code (four characters: YYWW) -Module serial number (eight characters, unique to each module)
6	JEDEC technical details (see JEDEC DDR5 DIMM Label Specification): -Module capacity, ranks, and number of data lines per DRAM device (256GB 2S16R x 16) -DRAM technology (PC5 shown) -Module speed bin (8800B shown) -Module type, reference raw card and revision (HZZ shown) JEDEC SPD revision (1010 shown) Temperature grade (XT shown)
7	Module DIMM type.
8	A process code is printed after the last character of module part numbers (ABCDEF shown; see Process Codes: DDR5). This additional information provided is not part of the module part number.
9	The European Regulatory Requirement mark (may or may not be present on a particular module label).
10	Module assembly country of origin; Micron uses: -“Made in Taiwan” for Taiwan origin product -“Assembled in USA” for US origin product -“Product of xxx” for products of other origins
11	The UK Regulatory Requirement mark (may or may not be present on a particular module label).
12	Module build lot ID.
13	Micron logo

DDR4/DDR3 Module Content: LRDIMM, RDIMM, UDIMM, and SODIMM

Figure 6: DDR4/DDR3 LRDIMM, RDIMM, UDIMM, and SODIMM Module Label Content

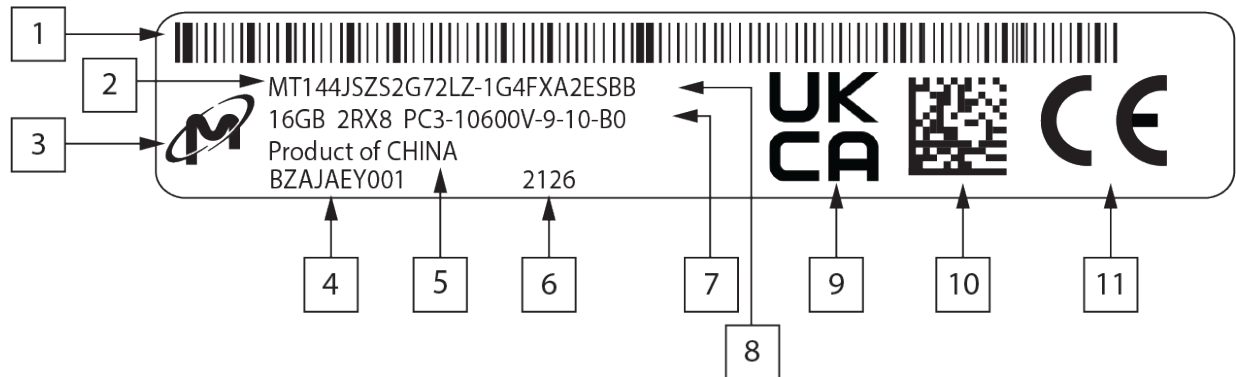

Table 5: Label Definitions: DDR4/DDR3 LRDIMM, RDIMM, UDIMM, and SODIMM

Note #	Definition
1	Code 128 subset B bar code (per ISO/IEC 15417:2007) of Micron part number/datecode (YWW) with a space separator between the data. Example: MTA18ASF1G72PDZ-2G6B1QG 126
2	Micron DRAM module marketing part number: For more information about module part numbering, see Module Part Numbering Systems on https://www.micron.com .
3	Micron logo.
4	Module build lot ID.
5	Module assembly country of origin; Micron uses: -"Made in Taiwan" for Taiwan origin product -"Assembled in USA" for US origin product -"Product of xxx" for products of other origins
6	Module date code, four characters (YYWW)
7	DDR4 JEDEC label text (see JEDEC document Module 4.20.28): -Module capacity, ranks, and number of data lines per DRAM device (8GB 2R X 8 shown) -DRAM technology (PC4 shown) -Module speed bin (2666V shown) Module type, reference raw card and revision (REB shown) JEDEC SPD revision (11 shown)
8	A process code is printed after the last character of RDIMM, LRDIMM, NVDIMM, and ECC UDIMM/SODIMM module part numbers (QG shown; see Process Codes: DDR3 and DDR4). This additional information is not part of the module part number. The process code for ECC UDIMM and SODIMM labels differ slightly as shown in the figure above. Labels on UDIMMs and SODIMMs without ECC do not have a process code appended to the part number.
9	The UK Regulatory Requirement mark (may or may not be present on a particular module label).
10	2D barcode – Encoded data string (per ISO/IEC 15426-2:2005): -Data identifier, S (constant on all modules) Micron’s JEDEC manufacturer code, 802C (constant on all modules) -Manufacturing location (two characters, variable—see Table 14) -Date code (four characters: YYWW) -Module serial number (eight characters, unique to each module)
11	The European Regulatory Requirement mark (may or may not be present on a particular module label).

DDR4/DDR3 Module Content: NVDIMM

Figure 7: DDR4/DDR3 NVDIMM Module Label Content

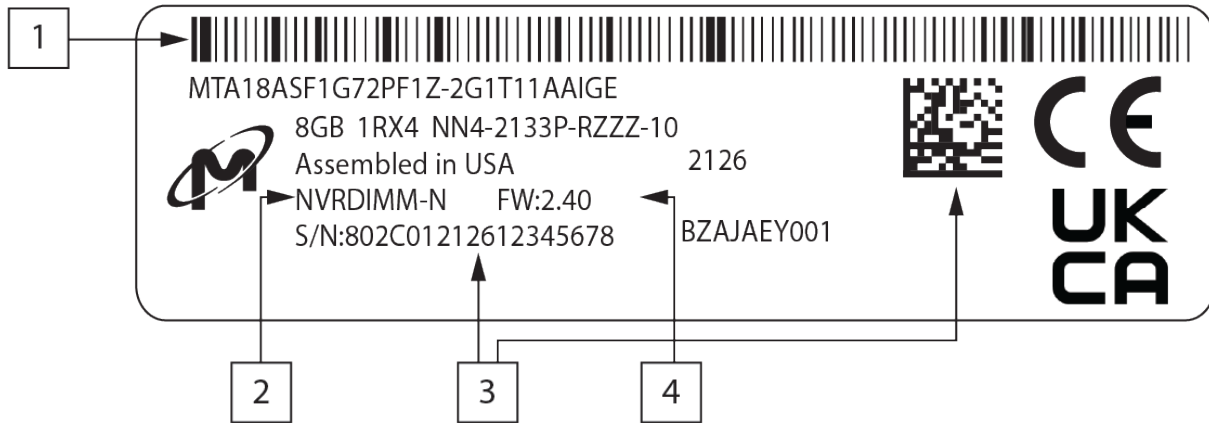

Table 6: Label Definitions: DDR4/DDR3 NVDIMM

Note #	Definition
1	The process code on the NVDIMM label includes a third character (E shown) that identifies the multiplexer (MUX) vendor and device ID (See Process Codes: DDR3 and DDR4).
2	JEDEC hybrid memory module type; function designators: -N = Persistent -F = Block -P = Combined
3	2D barcode and human-readable text – Encoded data string (per ISO/IEC 15426-2:2005): -Data identifier, S (constant on all modules), applies only to barcode area -Micron's JEDEC manufacturer code, 802C (constant on all modules) -Manufacturing location, two characters, variable —see Table 14) Datecode, four characters:YYWW -Module serial number (eight characters, unique to each module)
4	Firmware revision.

LPDDR5X Module Content: LPCAMM2

Figure 8: LPDDR5X LPCAMM2 Module

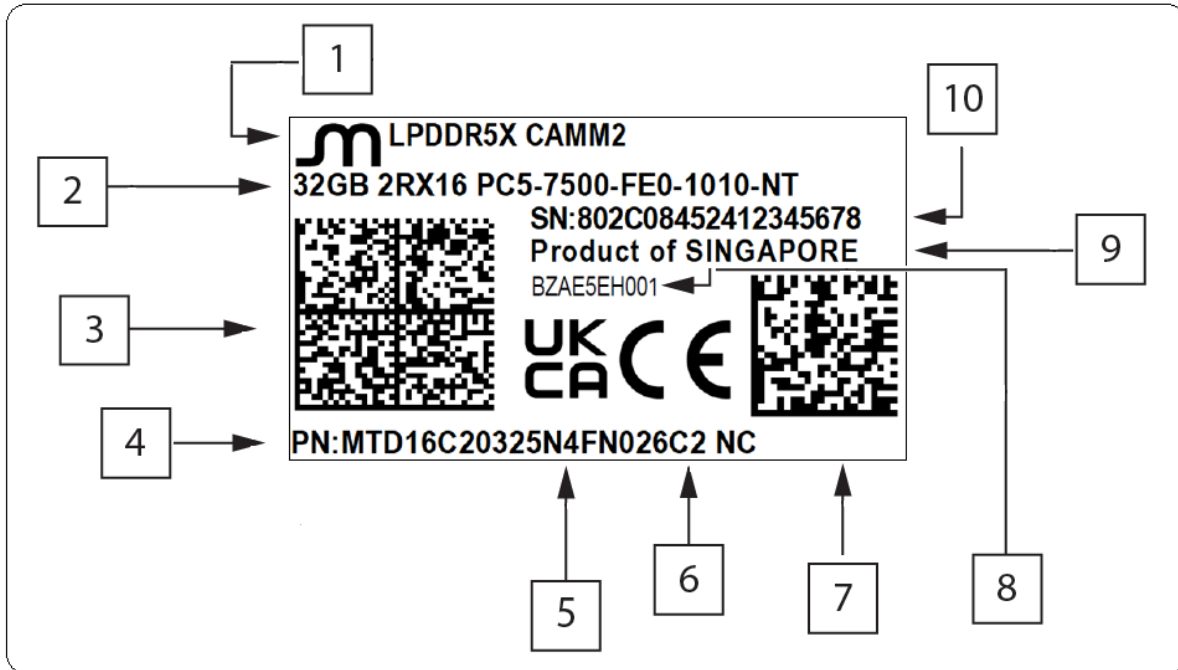

Table 7: Label Definitions: LPDDR5X LPCAMM2

Note #	Definition
1	Micron logo and CAMM2 technology
2	JEDEC technical details (see JEDEC DDR5 DIMM Label Specification): -Module capacity, ranks, and number of data lines per DRAM device (32GB 2RX16) -DRAM technology (PC5 shown) -Module speed bin (7500B shown) -Module type, reference raw card and revision (FEO shown) JEDEC SPD revision (1010 shown) Temperature grade (NT shown)
3	2D barcode (see JEDEC DDR5 DIMM Label Specification): (L) technical details (S) serial number (P) part number (c) process code.
4	Micron DRAM module marketing part number: For more information about module part numbering, see Module Part Numbering Systems on https://www.micron.com . A process code is printed after the last character of module part numbers (NT shown; see Process Codes: DDR5). This additional information provided is not part of the module part number.
5	The UK Regulatory Requirement mark (may or may not be present on a particular module label).
6	The European Regulatory Requirement mark (may or may not be present on a particular module label).
7	Bar code
8	Module build lot ID.
9	Module assembly country of origin; Micron uses: -"Made in Taiwan" for Taiwan origin product -"Assembled in USA" for US origin product -"Product of xxx" for products of other origins

Table 7: Label Definitions: LPDDR5X LPCAMM2 (Continued)

Note #	Definition
10	JEDEC serial number (see JEDEC DDR5 DIMM Label Specification): -Micron’s JEDEC manufacturer code, 802C (constant on all modules) -Manufacturing location (two characters, variable—see Table 14) -Date code (four characters: YYWW) -Module serial number (eight characters, unique to each module)

DDR4/DDR3 Module Content: ECC UDIMM/SODIMM

Figure 9: DDR4/DDR3 ECC UDIMM/SODIMM Module Label Content

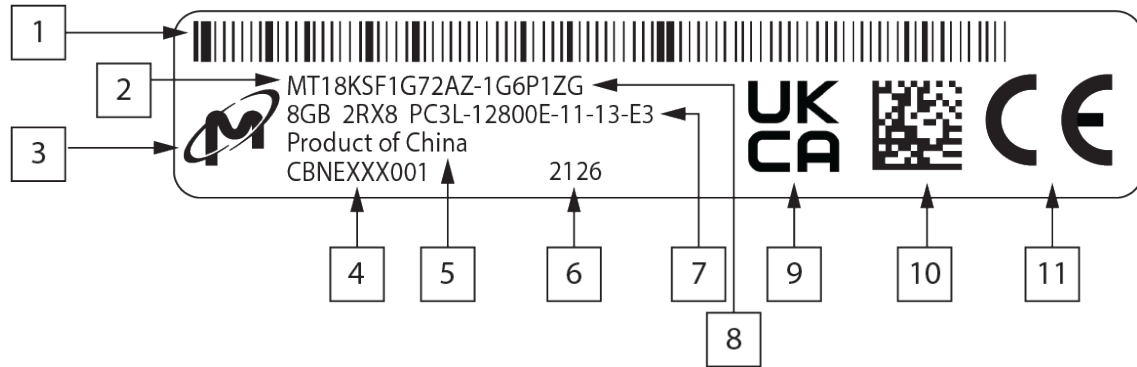

Table 8: Label Definitions: DDR4/DDR3 ECC UDIMM/SODIMM

Note #	Definition
1	Code 128 subset B bar code (per ISO/IEC 15417:2007) of Micron part number/datecode (YWW) with a space separator between the data.
2	Micron DRAM module marketing part number: For more information about module part numbering, see Module Part Numbering Systems on https://www.micron.com .
3	Micron logo.
4	Module build lot ID
5	Module assembly country of origin; Micron uses: -"Made in Taiwan" for Taiwan origin product -"Assembled in USA" for US origin product -"Product of xxx" for products of other origins
6	Module date code, four characters (YYWW)
7	DDR3 JEDEC label text (see JEDEC Doc. Module 4.20.20): -Module capacity (8GB shown) -Module ranks and number of data lines per DRAM device (2R X 8 shown) -DRAM technology and supply voltage (V_{DD} and PC3L shown) -Module speed bin (12800 shown) -Module type (E shown) -CAS Latency, in clocks (11 shown) -JEDEC SPD revision (13 shown) -Reference raw card and revision (E3 shown)
8	A two-character process code is printed after the last character of the module part numbers (ZG shown; see Process Codes: DDR3 and DDR4). This additional information provided is not part of the module part number. The first character of the process code, Z, is a place holder that means there is no register on the module The second character, G in this case, identifies the temperature sensor manufacturer and device version
9	The UK Regulatory Requirement mark (may or may not be present on a particular module label).
10	2D barcode – Encoded data string (per ISO/IEC 15426-2:2005): -Data identifier, S (constant on all modules) -Micron’s JEDEC manufacturer code, 802C (constant on all modules) -Manufacturing location (two characters, variable—see Table 14) -Date code (four characters: YYWW) -Module serial number (eight characters, unique to each module)
11	The European Regulatory Requirement mark (may or may not be present on a particular module label).

Process Codes

The following tables provide the process code options for the following devices:

- DDR3 register
- DDR4 register clock driver (RCD) and MUX
- DDR5 register clock driver (RCD), PMIC, HUB, and temperature sensor / EEPROM

Process Codes: DDR3 and DDR4

The following tables provide the process code options for DDR3 register and DDR4 register clock driver (RCD) and MUX.

Table 9: DDR3 Process Code Options

Register Vendor	Register Vendor ID (First Character)	Register Vendor Part Number	Temperature Sensor/EEPROM Vendor	Temperature Sensor/EEPROM Vendor (Second Character)	Temperature Sensor/EEPROM Vendor Part Number
IDT	D	SSTE32882HLBAKG8	ST Micro	E	STTS2002B2DN3F
	H	SSTE32882KA1AKG8	Microchip	F	MCP98243T-BE/MNYAA
	M	SSTE32882KB1AKG8	NXP	G	SE97BTP-547
Inphi	A	INSSTE32882LV-GS02			
	F	INSSTE32882UV-GS02			
	K	INSSTE32882XV-GS02			
Montage	N	M88SSTE32882H0-T			
TI	B	SN74SSQEA32882ZALR			
	G	SN74SSQEB32882ZALR			
	L	SN74SSQEC32882ZALR			
None	Z	-			

Table 10: DDR4 RDIMM, NVDIMM¹ Process Code Options

RCD Vendor	RCD Vendor ID (First Character)	RCD Vendor Part Number	Temperature Sensor/EEPROM Vendor	Temperature Sensor/EEPROM Vendor (Second Character)	Temperature Sensor/EEPROM Vendor Part Number
IDT	I	4RCD0124KC0ATG	IDT	G	TSE2004GB2B0NCG8
	S	4RCD0229KB1ATG8	ST Micro	I	STTS2004B2DN3F
	V	4RCD0232KC1ATG8	Microchip	K	MCP98244T-BE/MNY
Inphi	K	IDDR4RCD-GS02	Renasas	L	TSE2004GB2C0NCG8
	R	IDDR4RCD2-GS01			
Rambus	A (NVDIMM)	IDDR4NVRCD2-GS02			
	U	IDDR4RCD2-GS03			
Montage	H	M88DDR4RCD01B1-T			
	M	M88DDR4RCD01C0-T			
	Q	M88DDR4RCD02A0-T			
	T	M88DR4RCD02PH1			
TI	J	CAB4AZNRR			
None	Z	-			

Note: 1. DDR4 NVDIMMs' process code includes a third character that identifies the multiplexer (MUX) vendor and device version (see [Table 12: DDR4 NVDIMM Process Code Third Character Options](#) on page 17).

Table 11: DDR4 LRDIMM Process Code Options

RCD/ Data Buffer Vendor	RCD/Data Buffer Vendor ID (First Character)	RCD Vendor Part Number Data Buffer Vendor Part Number	Temperature Sensor/EEPROM Vendor	Temperature Sensor/EEPROM Vendor (Second Character)	Temperature Sensor/EEPROM Vendor Part Number
IDT	I	4RCD0124KC0ATG 4DB0124KB1AVG53	IDT	G	TSE2004GB2B0NCG8
	P	4RCD0124KC0ATG 4DB0226KA3AVG	ST Micro	I	STTS2004B2DN3F
	S	4RCD0229KB1ATG8 4DB0226KB0AVG8	Microchip	K	MCP98244T-BE/MNY
	V	4RCD0232KC1ATG8 4DB0232KC2AVG8	Renasas	L	TSE2004GB2C0NCG8
Montage	H	M88DDR4RCD01B1-T M88DDR4DB01A1-T			
	M	M88DDR4RCD01C0-T M88DDR4DB01B0-T			
	Q	M88DDR4RCD02A0-T M88DDR4DB02A1-T			
	T	M88DR4RCD02PH1 M88DR4DB02PH2-T			
None	Z	-			

Table 12: DDR4 NVDIMM Process Code Third Character Options

Mux Vendor	Process Code Character	Vendor Part Number
TI	D	TS3DDR4000ZBAR
NXP	E	CBTV24DD12

Process Codes: DDR5

The following tables provide the process code options for DDR5 RCD, PMIC, HUB, and temperature sensor/ EEPROM devices.

Table 13: DDR5 Process Code Options – Client SODIMMs and UDIMMs

Position (Client DIMMs < 6400 MT/s)	Position (Client DIMMs >= 6400 MT/s)	Position (RDIMM)	Code	Part Type	Vendor	Vendor Part Number	Generation	Rev.
1st	1st	N/A	B	Client PMIC	Renesas	P8911-Y0Z001FNG	5100	B0
1st	1st	N/A	C	Client PMIC	MPS	MP5431GLT-0010-Z	5100	R1
1st	1st	N/A	J	Client PMIC	Richtek	RTQ5132GQWF-310	5100	B1A
1st	1st	N/A	K	Client PMIC	MPS	MP5431GLT-0012-Z	5100	R2
1st	1st	N/A	N	Client PMIC	Richtek	RTQ5132GQWF-510	5100	B3
2nd	2nd	2nd	C	HUB	Renesas	SPD5118-Y1B000NCG	N/A	B1
2nd	2nd	2nd	F	HUB	Montage	M88SPD5118A5-T	N/A	A5
2nd	2nd	2nd	K	HUB	Rambus	SPD1605GA101	N/A	A1
N/A	3rd	3rd	F	Clock Driver	Montage	M88DR5CK01B0-T	Gen1	B0
N/A	3rd	3rd	G	Clock Driver	Renesas	RG5C172C0C0GBX	Gen1	C0
N/A	3rd	3rd	H	Clock Driver	Rambus	DDR5CKD1-GC0	Gen1	C0

Table 14: DDR5 Process Code Options – Server RDIMMs

Position (RDIMM)	Code	Part Type	Vendor	Vendor Part Number	Generation	Rev.
1st	F	Server PMIC	Renesas	P8900-X0Z001FNG	5000	D0
1st	G	Server PMIC	MPS	MPQ8895GU-0010-Z	5000	R3.5
1st	H	Server PMIC	MPS	MPQ8894GU-0010-Z	5010	R6.0
1st	I	Server PMIC	TI	TP553830RWZ	5000	D1
1st	J	Server PMIC	TI	TP553832RWZ	5010	D1
1st	M	Server PMIC	MPS	MPQ8895GU-0011-Z	5000	R6.1
1st	M	Server PMIC	Rambus	P2965XXGA011	5030	A0
1st	N	Server PMIC	MPS	MPQ8894GU-0011-Z	5010	R6.1
1st	N	Server PMIC	Renesas	RRG53221-A20	5030	A2
1st	P	Server PMIC	Richtek	RTQ5119AGQVF-71	5010	C5
1st	P	Server PMIC	MPS	MPQ8897GFC-00xx	5030	R1.4
1st	Q	Server PMIC	TI	TP553830ARWZR	5000	D2
1st	S	Server PMIC	TI	TP553832ARWZR	5010	D2
1st	U	Server PMIC	Renesas	P8900-X1Z001FNG	5000	D1
1st	W	Server PMIC	MPS	MPQ8896GU-0010	5020	R1
1st	X	Server PMIC	TI	TP553840RWZR	5020	A0
1st	Z	Server PMIC	Rambus	P1947XXGA112	5020	A1
1st	2	Server PMIC	MPS	MPQ8895GU-0023-Z	5000	R6.2
1st	3	Server PMIC	Renesas	P8900-W0Z001FNG8	5000	E0

Table 14: DDR5 Process Code Options – Server RDIMMs (Continued)

Position (RDIMM)	Code	Part Type	Vendor	Vendor Part Number	Generation	Rev.
2nd	C	RCD	Montage	M88DR5RCD05B0-T	Gen5	B0
2nd	G	RCD	Renesas	5RCD0148HC3AVG	Gen1	C3
2nd	G	RCD	Rambus	DR5RCD5GB1	Gen5	B1
2nd	H	RCD	Rambus	DDR5RCD1-G1EX	Gen1	D1 / G1EX
2nd	I	RCD	Montage	M88DR5RCD01B2	Gen1	B2
2nd	L	RCD	Rambus	DDR5RCD2-G1B	Gen2	G1B
2nd	M	RCD	Montage	M88DR5RCD02A1-T	Gen2	A1
2nd	P	RCD	Renesas	RG5R256A1C0GBY	Gen2	A1
2nd	S	RCD	Rambus	DDR5RCD3-G1A	Gen3	A0
2nd	W	RCD	Montage	M88DR5RCD03A1	Gen3	A1
2nd	X	RCD	Renesas	RG5R364B0C0GBY	Gen3	B0
2nd	Z	RCD	Renesas	RRG50041-A00	Gen4	A0
2nd	5	RCD	Montage	M88DR5RCD04A1-T	Gen4	A1
2nd	6	RCD	Rambus	DR5RCD4GA1	Gen4	A1
2nd	8	RCD	Renesas	RRG50050/1-B00	Gen5	B0
3rd	C	HUB	Renesas	SPD5118-Y1B000NCG	N/A	B1
3rd	F	HUB	Montage	M88SPD5118A5-T	N/A	A5
3rd	K	HUB	Rambus	SPD1605GA101	N/A	A1
4th	C	TempSensor	Renesas	TS5111-Z2AHRI	N/A	A2
4th	F	TempSensor	Montage	M88TS5110A4-T	N/A	A4
4th	H	TempSensor	TI	TMP139AIYAGR	N/A	PG3.2
4th	K	TempSensor	Rambus	SPD1605GA101	N/A	A1

Table 15: DDR5 Process Code Options – Server MRDIMMs

Position (RDIMM)	Code	Part Type	Vendor	Vendor Part Number	Generation	Rev.
1st	M	Server PMIC	Rambus	P2965XXGA011	5030	A0
1st	N	Server PMIC	Renesas	RRG53221-A20	5030	A2
1st	P	Server PMIC	MPS	MPQ8897GFC-00xx	5030	R1.4
2nd	C	MRDIMM RCD	Renesas	RG5R188B0AIGBY	Gen1	C0
2nd	F	MRDIMM RCD	Montage	M88MR5RCD01B1	Gen1	B1
3rd	C	HUB	Renesas	SPD5118-Y1B000NCG	N/A	B1
3rd	F	HUB	Montage	M88SPD5118A5-T	N/A	A5
3rd	K	HUB	Rambus	SPD1605GA101	N/A	A1
4th	C	TempSensor	Renesas	TS5111-Z2AHRI	N/A	A2
4th	F	TempSensor	Montage	M88TS5110A4-T	N/A	A4
4th	H	TempSensor	TI	TMP139AIYHR	N/A	PG3.2
4th	K	TempSensor	Rambus	SPD1605GA101	N/A	A1
5th	G	MRDIMM Data Buffer	Montage	M88MR5DB01B1	Gen1	B1
5th	C	MRDIMM Data Buffer	Renesas	RG5D188C1AIGBX	Gen1	C1

Table 16: Module Manufacturing Locations

Module Manufacturing Location	ID Number (Decimal)	Hexadecimal Number
SIG (USA)	1	0x01
MTB (Taiwan)	2	0x02
MNG (Malaysia)	5	0x05
MMP (Malaysia)	6	0x06
MNI (India)	7	0x07
SING (Singapore)	8	0x08
MSI (India)	10	0x0A
MXA (China)	15	0x0F
TSMT (Taiwan)	37	0x25
Hotayi (Malaysia)	26	0x1A

Label Information

Figures 9 through 14 show representative label structures for our products. The table below provides the details of each particular item found on the various labels. Not all items are present on all labels. Micron has added a manufacturing identification (MID) label to all products. This 2D barcode label is for Micron internal use only.

Figure 10: SSD MID Label



Table 17: Label Mark Definitions



Mark or Text Example	Definition
micron	New Micron logos. Refer to Micron Information Notice 35718.
m	
Micron	Old Micron logos. Refer to Micron Information Notice 35718. Contact your Sales Representative with any questions.
	
XXXX U.X	Market segment, form factor, product and FIPS security (if applicable). Example: 1100 2.5 SSD FIPS 140-2 L2.
XV X.XA	The device's voltage level with its related amperes at normal operation (defined by Micron QRA).
FW: XXXXXXXX	Drive firmware revision number
	Data matrix (2D) barcode containing the PSID (if applicable for a security feature enabled drive) or the drive serial number, drive part number and PSID.
FCC	Reserved for the official USA Federal Communications Commission (FCC) mark.

Table 17: Label Mark Definitions (Continued)









Mark or Text Example	Definition
	Reserved for the official China Restriction of Hazardous Substances mark. This device must meet the standards of China RoHS to enable the 20 year indication of the RoHS mark.
	Reserved for the official Japan VCCI mark.
	Reserved for the official mark based on the drive interface (SATA, NVMe, and so on).
	
	Reserved for the official Ukraine mark.
	Reserved for the official Taiwan Bureau of Standards Metrology and Inspection (BSMI) mark. In addition, the certification number assigned to this Micron product shall be listed below the mark in a legible font.
	Reserved for the official European Regulatory Requirement mark.
CAN ICES-3(X)/NMB-3(X)	Reserved for the official industry of Canada certification number.
	Reserved for official UK Regulatory Requirement mark.
	Reserved for the official RCM (Australian) mark.

Table 17: Label Mark Definitions (Continued)







Mark or Text Example	Definition
	Reserved for the official European Waste Electrical and Electronics Equipment (WEEE) mark.
	Reserved for the official TUV mark.
	Reserved for the official Underwriters Laboratories (UL) mark.
	Reserved for the official Morocco mark.
	Reserved for the official Korean Certification (KC) mark. In addition, the certification number assigned to this Micron product shall be listed near the mark in a legible font. Example: MSIP-REM-MU2-MTFDDAKXXXXXX or R-R-MU2-MTFDXXXXXXXXXX
	Warning Hot Surface symbol.
PSID: XXXXXXXX-XXXX-XXXX-XXXX-XXXXXXXXXXXX	PSID alphanumeric code.
Product of: XXXXXXXX	Country where the device is assembled, written in English; Micron uses: -“Made in Taiwan” for Taiwan origin product. -“Assembled in USA” for US origin product. -“Product of XXXX” for products of other origins.
LN: XXXXXXXXXX	Lot number for tracking the drive’s manufacturing data. This is listed as xxyyyzzz: -xx = 2 digits to denote manufacturing site -yyyyy = 5 digits to denote the kit number (randomly generated) -zzz = 3 digits denoting a subplot size (to provide greater resolution of manufacturing information)
HALOGEN-FREE	Halogen-free mark indicating that the drive meets the IPC low-halogen requirements
SN: YYWWXXXXXXXX	Drive serial number. -Format: 12 characters: YYWWXXXXXXXX. -YY is the current year. -WW is the current Micron workweek. -XXXXXXXX is an eight digit hex (base 16 0–9, A–F) serial number.

Table 17: Label Mark Definitions (Continued)













Mark or Text Example	Definition
OCP SN: WWYYXXXXXXXXXX	Drive serial number. -Format: 12 characters: WWYYXXXXXXXXXX. -WW is the current Micron workweek. -YY is the current year. -XXXXXXXX is an eight digit hex (base 16 0–9, A–F) serial number.
	Drive serial number bar code data for item above (follows the Code 128 standard). (The example shown is a representation, not an actual barcode).
PN: MTFDXXXXXXXXXX- XXXXXXXXXX	Drive part number.
	Drive part number bar code data for item above (follows the Code 128 standard). (The example shown is a representation, not an actual barcode)
MTFDXXXXXXXXXX	Micron model number.
MDL:MTFDXXXXXXXXXX	
EUI-64:00A0750XXXXXXXXXX	EUI-64 number
Yellow bar	Applicable to select products, a yellow bar may or may not be present on the label edge and may indicate Gen4 product.

Figure 11: Micron Standard OCP E1.S/L, U.2/U.3, E3.S SSD Label Structures

XXXX XXX XX.X XXXX XXV XXA XXXX XX STORAGE DEVICE
 SN:WWYYXXXXXXXXX XXXXTB HW REV:X.X
 PN:MTFDXXXXXXXXX-XXXXXXXXX NVMe™ XXX
 MDL: MTFDXXXXXXXXX LN:XXXXXXXXXX FW:XXXXXXX
 <Empty> PSID:(XXXXXXXXXXXXXXXXXXXXXXXXXXXXXXXXXXXX)
 PRODUCT OF (MODASM)
 R-R-MU2-MTFDXXXXXXXXX
 CAN ICES-X(X)/XXX-X(X)
 www.micron.com

micron

PN: MTFDXXXXXXXXX-XXXXXXXXX
 SN: WWYYXXXXXXXXX
 MODEL: MTFDXXXXXXXXX

FW: XXXXXXXX
 XXXXTB
 XXV XXA
 HW REV: X.X
 LN: XXXXXXXXXX
 STORAGE DEVICE

PSID: XXXXXXXXXXXXXXXXXXXXXXXXXXXXXXXXXXXX

PRODUCT OF (MODASM)
 CAN ICES-X(X)/XXX-X(X)
 R-R-MU2-MTFDXXXXXXXXX

www.micron.com













XXXX XXX XX XXXX XXXXTB XXXX XX
 XXV XXA NVMe™ STORAGE DEVICE
 SN:WWYYXXXXXXXXX FW:XXXXXXX
 PN:MTFDXXXXXXXXX-XXXXXXXXX
 MDL: MTFDXXXXXXXXX HW REV:X.X
 LN:XXXXXXXXXX XXX
 PSID:XXXXXXXXXXXXXXXXXXXXXXXXXXXXXXXXXXXX

PRODUCT OF (MODASM)
 R-R-MU2-MTFDXXXXXXXXX
 CAN ICES-X(X)/XXX-X(X)
 www.micron.com





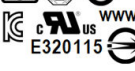

















Figure 12: Micron Standard SATA/NVMe 2.5/U.x SSD Label Structures

micron XXXX 2.5

Model: MTFDXXXXXXXXXX F/W: XXXXXXXX



P/N: MTFDXXXXXXXX-XXXXXXX



S/N: YYWW12345678

XXXXGB SATA 6Gb/s SED XV X.XA

L/N: XXXXXXXXXX HALOGEN FREE

Product of XXXXXXXXX

PSID: XXXXXXXX-XXXX-XXXX-XXXXXXXXXXXX



R-R-MU2-MTFDXXXXXXXXXX www.micron.com CAN ICES-3(X)/NMB-3(X)

micron XXXX U.X XXXXGB

XV XA GenX xX F/W: XXXXXXXX

SED

LN: XXXXXXXXXX NVMe MODEL: MTFDXXXXXXXXXX



P/N: MTFDXXXXXXXXXX-XXXXXXX



SN: YYWWXXXXXXXXXX

PRODUCT OF XXXXXXXX

R-R-MU2-MTFDXXXXXXXXXX



CAN ICES-3(X)/NMB-3(X)



PSID: XXXXXXXX-XXXX-XXXX-XXXX-XXXXXXXXXXXX



www.micron.com



Figure 13: Micron Standard SATA/NVMe M.2 SSD Label Structures

 <p>XXXX M.2 XXXXGB SATA XGb/s SED L/N: XXXXXXXXXXXX Model: MTFDXXXXXXXXXX P/N: MTFDXXXXXXXXXX-XXXXXXXXXX S/N: YYWW12345678 Product of XXXXXXXX www.micron.com X.XV X.XA PSID: XXXXXXXX-XXXX-XXXX-XXXX-XXXXXXXXXXXX</p>	<p>F/W: XXXXXXXX</p>  <p>R-R-MU2-MTFDXXXXXXXXXX HALOGEN FREE</p>	
--	--	---

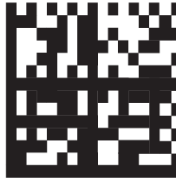
 <p>XXXX XXXXGB PN: MTFDXXXXXXXXXX-XXXXXXXXXX MDL: MTFDXXXXXXXXXX R-R-MU2-MTFDXXXXXXXXXX PSID: XXXXXXXX-XXXX-XXXX-XXXX-XXXXXXXXXXXX</p>	<p>XV XA GenX xX EUI-64:00A0750XXXXXXXXXX SN: YYWWXXXXXXXXXX</p>	<p>FW: XXXXXXXX SED PRODUCT OF XXXXXXXX</p> 
 <p>NVM express™ Leopoldstrasse 250 Munich 80807 Germany SSD (????) London Rd Bracknell RG12 2AA UK</p>		

 <p>XXXX XXXXGB M.2 SED LN: YYWWXXXXXXXXXX SN: YYWWXXXXXXXXXX EUI-64:00A0750XXXXXXXXXX PSID: XXXXXXXX-XXXX-XXXX-XXXX-XXXXXXXXXXXX</p>	<p>XV XA MODEL: MTFDHBAXXXXXXX PN: MTFDHBAXXXXXXX-XXXXXXXXXX R-R-MU2-MTFDHBAXXXXXXX PRODUCT OF XXXXXXXX NVM express™</p>	<p>NVMe GenX xX FW: XXXXXXXX</p> 
--	--	--

 <p>XXXX XXXXGB SED FW: XXXXXXXX XV XA PN: MTFDXXXXXXXXXX-XXXXXXXXXX MDL: MTFDXXXXXXXXXX GenX xX PRODUCT OF XXXXXXXX R-R-MU2-MTFDXXXXXXXXXX PSID: XXXXXXXX-XXXX-XXXX-XXX X-XXXXXXXXXXXXXX EUI-64:00A075011 1235678 SN: YYWW12345678</p>	
 <p>NVM express™ Leopoldstrasse 250 Munich 80807 Germany SSD (????) London Rd Bracknell RG12 2AA UK</p>	

 <p>xxxx XXXXGB M.2 SED LN: XXXXXXXXX R-R-MU2-MTFDXXXXXXXXXX EUI-64:00A075011235678 MODEL: MTFDXXXXXXXXXX PN: MTFDXXXXXXXXXX-XXXXXXXXXX SN: YYWW12345678 PRODUCT OF XXXXXXXXX NVM express™ PSID: XXXXXXXX-XXXX-XX XX-XXXX-XXXXXXXXXXXXXX</p>	<p>GenX xX XV XA FW: XXXXXXXX</p> 
---	---

Not shown is the worldwide name assigned to Micron (as defined by IEEE), which may or may not be present on the label. WWN: 500A0751XXXXXXXX

Figure 14: Micron Standard NVMe E1.x SSD Label Structures

Example 1

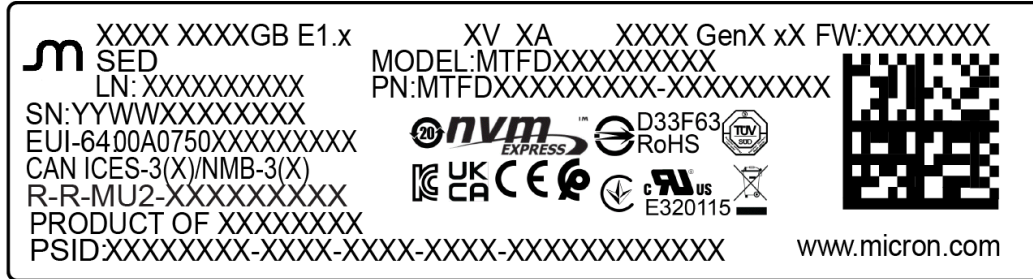

Example 2



Not shown is the worldwide name assigned to Micron (as defined by IEEE), which may or may not be present on the label. WWN: 500A0751XXXXXXXX

Figure 15: MID/CERT Label Structure

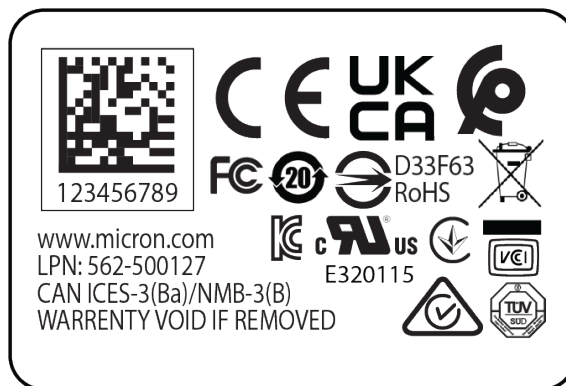

The MID/CERT label may be used as needed where an SSD label does not include regulatory marks. The printed label has a black background with the text and marks in white.

Figure 16: Embedded USB Label Structure



Labels for engineering samples
replace these logos with text:
ENGINEERING SAMPLE.

SD and microSD Label Information

Figure 15 shows a representative front label structure for our SD and microSD products. Figure 17 shows the backside markings. The figures are accompanied by label content definition tables that explain the details of each particular item.

Figure 17: Micron SD Label Structure

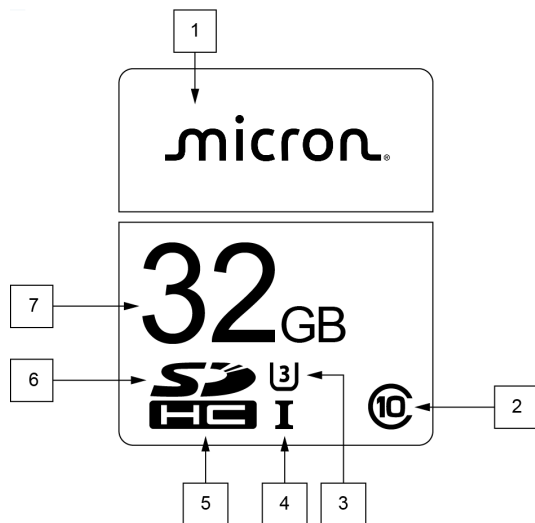

Table 18: Label Content Definitions: Micron SD Label Structure

Note #	Definition
1	Micron logo
2	Speed class rating
3	UHS speed class rating
4	UHS rating
5	Type
6	Form factor
7	Capacity

Figure 18: Micron microSD Label Structure

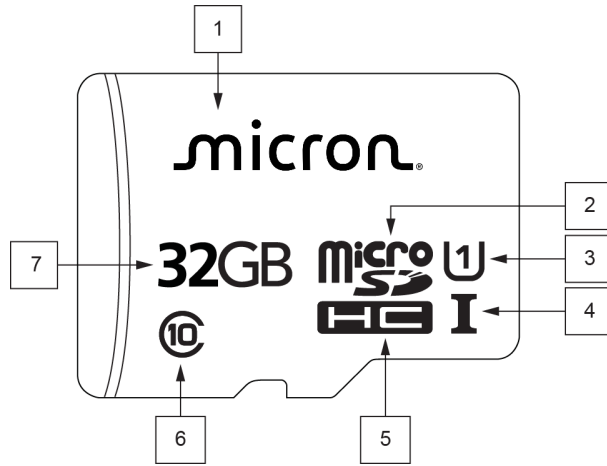

Table 19: Label Content Definitions: Micron microSD Label Structure

Note #	Definition
1	Micron logo
2	Form factor
3	UHS speed class rating
4	UHS rating
5	Type
6	Speed class rating
7	Capacity

Figure 19: Micron SD Backside Markings

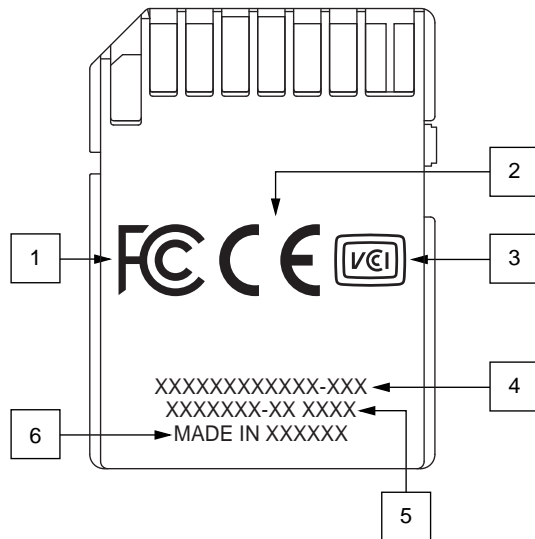

Table 20: Label Content Definitions: Micron SD Backside Markings

Note #	Definition
1	Reserved for the official USA Federal Communications Commission (FCC) mark
2	Reserved for the official European Regulatory Requirement mark
3	Reserved for the official Japan VCCI mark
4	Micron part number
5	Lot number and date code
6	Country of origin

Figure 20: Micron microSD Backside Markings

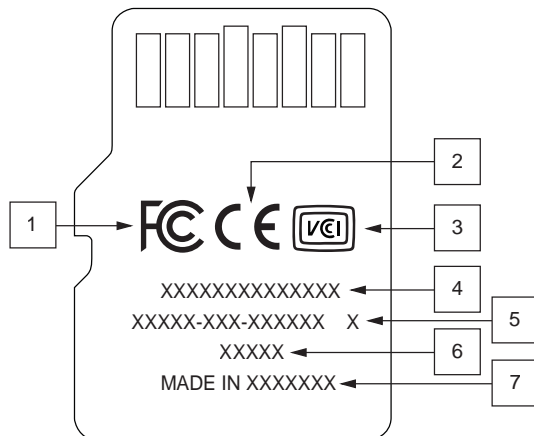

Table 21: Label Content Definitions: Micron microSD Backside Markings

Note #	Definition
1	Reserved for the official USA Federal Communications Commission (FCC) mark
2	Reserved for the official European Regulatory Requirement mark
3	Reserved for the official Japan VCCI mark
4	Micron part number
5	Lot number and date code
6	Country of origin

Micron Packaging Labels

Micron uses various packaging labels to enable quick identification of packaged contents, provide a simple order verification method, and indicate inner-package moisture levels. All labels are manufactured from matte-coated facestock or synthetic paper and contain acrylic- or water-based adhesive. See CSN-16 for complete information on all Micron packaging materials, including recyclable materials.

Master Container Labels

For all shipments, Micron uses standard bar code labels that conform to EIA Standard 556. The bar code labels enable customers to scan Micron containers for quick order verification. Figure 20 on page 28 shows an example of the standard bar code label used on master containers. Each box also carries its own bar code label (see the Individual Packaging Labels section).

Bar Code Information







The following information appears on the master container labels only:

- (3S/4S) - PKG ID: Invoice or packing slip number.
- (1P) - SPLR PROD ID: Reserved for individual customer requirements.
- (Q) - QUANTITY: Number of parts in master container.
- (K) - TRANS ID: Customer purchase order number.
- (P) - CUST PART NO: If a customer part number is not designated, the Micron part number will be printed.
- (4L) - Origin: The country in which the product was made.

Figure 21: Standard Master Container Shipping Label



Figure 22: Standard Master Container Bar Code Label

(S3) PKG ID: 424419177A1 	Ship_To_Name Address City, ST ZIP Code Country
(Q) QUANTITY: 2000 	PACKAGE COUNT: 1 OF 1 13.3 x 13.3 x 2.3 in 34.3 x 34.3 x 6.3 CM Micron Semiconductor Xian Co. LTD Zone B of Shaanxi Xian EPZ Xinxi Avenue, Gaoxim District 710119 XIAN CHINA
(1P) SPLR PROD ID: MT41K128M16JT -125:K 	
(K) TRANS ID: MHK241118 - PM - K2 - F6 	(4L) Origin Fab: US 
(P) CUST PART NO: MT41K128M16JT - 125:K 	(4L) Origin Asm: CN 
PACKAGE WEIGHT 11.0 LBS / 5.0 KGS	SHIP DATE 04/21/2025

Note: 1. Additional Information: For Integrated Circuits, both Origin Fab and Origin Asm will be printed; For Modules, SSDs, only the line with Origin Asm will be printed; For Die/Wafer, only the line with Origin Fab will be printed

Additional Label Information

The following information appears in the upper right and bottom portion of the master container labels and may differ slightly depending on whether the label has a (3S) or (4S) PKG ID:

- Ship-to name: Customer’s name and ship-to address.
- Ship-from name: Micron’s name and address.
- PACKAGE COUNT (3S): Master container package count, or TOTAL COUNT (4S): Master container package count: (3S) label includes master container size in inches and centimeters.
- PACKAGE WEIGHT (3S): Package weight in pounds and kilograms, or TOTAL WEIGHT (4S): Master container weight in pounds and kilograms.
- SHIP DATE: Date the product leaves the factory.

Individual Packaging Labels

For quick order verification, Micron attaches a standard bar code label and inner packing container label on the inner packing container. Additionally, the moisture barrier or static-shielding bag has a moisture sensitivity (MST) label and a standard bar code label attached to the front. If ordering in tape and reel, the tape-and-reel carrier will have a standard bar code label attached. Figure 21 on page 29 shows an example of the standard bar code label, Figure 22 on page 29 shows an example of Micron’s inner packing container label, and Figure 24 on page 30 shows an example of Micron’s MST label. Refer to Figure 25 on page 30 for approximate placement of these labels on Micron’s moisture-barrier and static-shielding bags.

Figure 23: Standard Bar Code Label

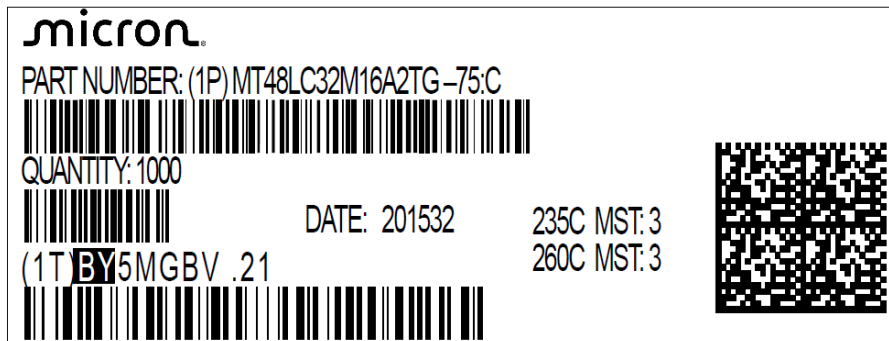







Figure 22, Micron’s Inner Packing Container Label, indicates the RoHS status of compliance with either RoHS or RoHS and HF (for those products that are also free of halogens). This space will be blank on labels for containers that hold parts with lead. Also, an asterisk (*) at the end of the date code indicates that the container holds a mix of product from more than one date; the date shown is that of the oldest product in the container. The “VID...” text is printed on the label as applicable for specific products.

Figure 24: Micron’s Inner Packing Container Label for Packaged Components



Note: 1. The above labels are for Micron internal use and some barcodes may be coded with additional info.

Figure 25: Micron’s Inner Packing Container Label for Modules and SSDs

		BO  Leopoldstrasse 250 Munich 80807 Germany		UK  London Rd Bracknell CA RG12 2AA UK	
FH118GS.RQ		Origin China		FAB 6	
		MOD		RoHS	
QTY: 100	(9D) 201944	HT		135789	
					
MT18KSF51272PDZ — 1G6K1FG					

- Notes: 1. The European Regulatory Requirement mark may or may not be present on a particular inner packing label.
- 2. Some module product labels may include additional characters after the Micron marketing part number. For more information, see the Module Label Data section.
- 3. The above labels are for Micron internal use and some barcodes may be coded with additional info.

Figure 26: Micron’s Moisture Sensitivity (MST) Label

235C	Peak Package Body Temp	Moisture Level:	<input type="text" value="3"/>
Floor Life: 168 hours Condition <= 30 deg. C/60% RH			
<hr/>			
260C	Peak Package Body Temp	Moisture Level:	<input type="text" value="3"/>
Floor Life: 168 hours Condition <= 30 deg. C/60% RH			
<hr/>			
Package Seal Date: Mar 21 2023			
micron		BY2BFT1.41	

Figure 27: Labeling on Moisture-Barrier and Static-Shielding Bags¹



- Notes: 1. This figure indicates the approximate locations only of the various labels.
 2. Internal labels are applicable to tube and tray shipments only and may or may not be present on every bag.
 3. See the Micron’s Moisture Sensitivity (MST) Label figure.
 4. See the Standard Bar Code Label figure.

Revision History

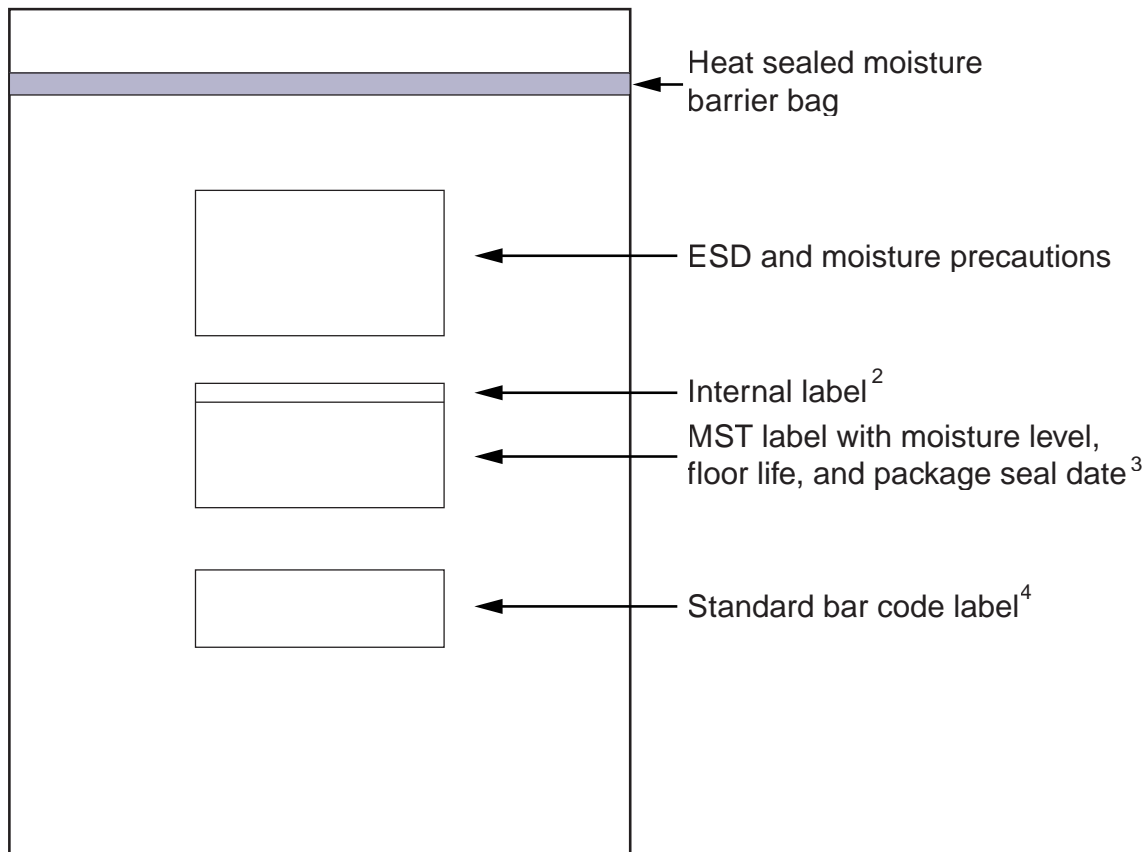
Rev. BF – 05/2026

- Under "Process Codes: DDR5," replaced the "DDR5 Process Codes Options" table with three new tables as follows: "DDR5 Process Code Options – Client SODIMMs and UDIMMs" Table; "DDR5 Process Code Options – Server RDIMMs" Table; and "DDR5 Process Code Options – Server MRDIMMs" Table.

Rev. BE – 12/2025

- Added OCP row to Label Mark Definitions table.
- Added OCP images following the Label Mark Definitions table.

Rev. BD – 09/2025

- Corrected table numbers in: Label Definitions: DDR5 LRDIMM to SODIMM table, Label Definitions: DDR5 MRDIMM table, Label Definitions: DDR4/DDR3 LRDIMM, RDIMM, UDIMM, and SODIMM table, Label Definitions: DDR4/DDR3 NVDIMM table, Label Definitions: LPDDR5X LPCAMM2 table, and Label Definitions: DDR4/DDR3 ECC UDIMM/SODIMM table.

Rev. BC – 07/2025

- Updated Figure 21: Standard Master Container Bar Code Label.
- Updated Figure 23: Micron's Inner Packing Container Label for Packaged Components.

Rev. BB – 05/2025

- Updated Component Marks table.
- Updated Country Codes table.
- Updated SOP2/W-PDFN/BGA/LGA Abbreviated Component Mark figure.
- Updated DDR5 Process Code Options table.

Rev. BA – 04/2025

- Updated Model Manufacturing Locations table with information for India.

Rev. AZ – 03/2025

- Updated Micron logo.
- Added LPCAMM2.

Rev. AY – 10/2024

- Added the following Note for figures "Micron's Inner Packing Container Label" and "Micron's Inner Packing Container Label for Modules and SSDs": The above labels are for Micron internal use and some barcodes may be coded with additional info.

Rev. AX – 07/2024

- Updated DDR5 Process Code Options Table.

Rev. AW – 03/2024

- Updated DDR5 Process Code Options Table.

Rev. AV – 12/2023

- Added DDR5 MRDIMM DRAM Module Label Content.
- Updated Micron's Moisture Sensitivity (MST) Label.

Rev. AU – 12/2022

- Updated DDR5 Process Code Options Table.

Rev. AT – 06/2022

- Updated Standard Master Container Bar Code Label figure.

Rev. AS – 03/2022

- Updated DDR5 Process Code Options Table.

Rev. AR – 07/2015

- Updated DDR5 Process Code Options Table.

Rev. AQ – 11/2021

- Updated DDR5 Process Code Options Table.
- Updated figures in the "Module Label Data and Examples" section.
- Updated figures and text in the "SSD Label Information" section.

Rev. AP – 07/2021

- Updated figures 2 and 3 in the "Abbreviated Component Mark Information" section and figure 6 in the "Module Label Data and Examples" section..
- Updated figures 4, 5, and 7 in the "Module Label Data and Examples" section.
- Removed "DDR5 NVDIMM" section.

Rev. AO – 01/2021

- Updated figure 4 in the "Module Label Data and Examples" section.

Rev. AN – 01/2021

- Added figures 4 and 5 in the "Module Label Data and Examples" section.
- Updated figures 6, 7, and 8 in the "Module Label Data and Examples" section and figure 21 in the "Individual Packaging Labels" section.
- Updated the DDR5 Process Code Options Table.
- Removed the following figures: 2.5-inch Label Structure - M5XX(DC/IT)/M600 and mSATA Label Structure - M6XX and mSATA Label Structure - M6XX

Rev. AM – 09/2019

- Updated the DDR5 Process Code Options Table.

Rev. AL – 04/2019

- Updated country of origin key note text for Figures 4, 6, 8, 9, 10, and 11
- Added "Reserved for the official Industry of Canada certification number" to Figure 8 key notes.
- Updated Figure 18 1P and P fields and added note 1
- Updated Figure 21 and added note 2

Rev. AK – 11/2018

- Updated Figure 5 and notes.
- Updated Table 5 DDR5 Process Code Options Table.
- Updated Figures 8, 10, 18 and 20.

Rev. AJ – 08/2018

- Added note 2 to Figure 2.
- Added the official Morocco mark to Figures 8 and 10.
- Updated Figure 20.

Rev. AI – 03/2018

- Updated tables 2 and 3.

Rev. AH – 12/2017

- Added SD and microSD Label Information.

Rev. AG – 10/2017

- Updated figures 8 through 11.

Rev. AF – 07/2017

- Updated figure 16.

Rev. AE – 05/2017

- Updated Data matrix (2D) barcode description for Figure 10.
- Deleted Figures 11 and 12 (EoL product).

Rev. AD – 03/2017

- Updated Figure 16 and the following explanatory paragraphs.

Rev. AC – 11/2016

- Added Table of Contents and List of Figures.
- Updated Figures 1 and 2.
- Updated and expanded Module Label Data and Examples (Added Process Codes).
- Updated all SSD labels and key note definitions.
- Updated Figures 15 through 19.

Rev. AB – 05/2016

- Added DDR3, DDR4 Process Code Reference section.

Rev. AA – 03/2016

- Corrected typo in Note 3 of Figure 4.
- Updated Figures 12, 16 and added new Figure 17. 1/16.

Rev. Z – 10/2015

- Updated module label explanation and notes.
- Added M6xx SSD labels.
- Deleted links to specific SSD label figures under SSD Label Information.
- Added Table of Contents and List of Figures.
- Updated Figure 2 title.

Rev. Y – 07/2015

- Added SSD MID label.

Rev. X – 05/2015

- Updated Figure 4.
- Updated Figure 23.

Rev. W – 05/2015

- Added Note 2 to Figure 4.

Rev. V – 10/2014

- Updated information on page one.
- Added information for legacy components with Elpida part marks.
- Added DC and IT mark to M5xx SSD label title.
- Added 2.5in P420m label information.

Rev. U – 07/2014

- Added M.2 M510/M550 label.

Rev. T – 01/2014

- Added “.../date code (YWW)” to Line 1 of the Module Label Information section.

Rev. S – 12/2013

- Added European Regulatory Requirement logo and note to Figures 3 and 20.
- Corrected numbering on pages 4 and 5.

Rev. R – 08/2013

- Updated Inner Packing Container and Standard Master Container Shipping labels.

Rev. Q – 07/2013

- Added new SSD labels.

Rev. P – 02/2013

- Updated Inner Packing Container and Standard Master Container Shipping labels.
- Corrected note references for Figure 15.

Rev. O – 06/2012

- Added Microdisplay panel label.

Rev. N – 03/2012

- Added the Embedded USB label.

Rev. M – 02/2012

- Added the SSD mSATA label.

Rev. L – 02/2012

- Corrected references in Figure 12.

Rev. K – 10/2011

- Updated security feature set to Figure 6 and it’s notes.

Rev. J – 06/2011

- Added aliases to the links for the part numbering guides and FBGA date codes, and the FBGA Part Marking Decoder.
- Added specific date code information.
- Updated country codes.
- Added SSD C400 label information.

Rev. H – 02/2010

- Added date code information to the text for Figure 9.

Rev. G – 01/2010

- Corrected typo.

Rev. F – 12/2009

- Added SSD product labels.
- Added packaging label information from CSN-16.

Rev. E – 10/2009

- Updated template.
- Updated Figure 3, “Module Label.”

Rev. D – 06/2008

- Added Korea to note 1 country codes.
- Updated and renamed Figure 2.
- Deleted Figure 3, “DDR2/GDDR3 FBGA Abbreviated Component Mark.”

Rev. C – 05/2007

- Added Taiwan to note 1 country codes.

Rev. B – 12/2005

- Added logo information to Figure 1 on page 6 and Figure 2 on page 7.

Rev. A – 02/2005

- Added China to note 1 country code.